



# BATH VENTILATION SOLUTIONS



## PRODUCT CATALOG

IMPROVING INDOOR AIR QUALITY THROUGH BETTER VENTILATION

[www.fantech.net](http://www.fantech.net)

# Designing a Luxury Bath



You've spent hours pouring over magazines to find the perfect design for your new spa-like bathroom retreat. You've chosen the perfect tile, the whirlpool tub, beautiful faucets and luxurious shower sprays.

Don't stop there. Insist on a Fantech ultra-quiet Premium Bath Fan or Fan with Light to protect your new dream bath from the harmful effects of moisture, steam and odors.

It's powerful ventilation that you can live with.



IMPROVING INDOOR AIR QUALITY THROUGH BETTER VENTILATION

# The Ultimate in Design Flexibility plus Quiet Operation!

Don't let the roar of a noisy bath fan disrupt your peace and quiet. Protect your bath and your sanity with Fantech Premium Bath Fans. Unlike standard bath exhaust fans, the motor of a Fantech fan mounts away from the living area. The result is powerful yet quiet ventilation you can live with.

## A New Level of Flexibility

No other exhaust fan in the market today offers more design flexibility at installation. Several exhaust grilles can easily be connected to one remote fan motor for effective spot ventilation in a single bath. Or, use one fan to ventilate two back-to-back baths.

## Perfect Spot Ventilation

Small, unobtrusive Ceiling Grilles with or without Lights mount in the shower, over the toilet or over the whirlpool tub. Its the ideal way to exhaust contaminants quickly and efficiently while reducing the damaging effects of mold-causing moisture.

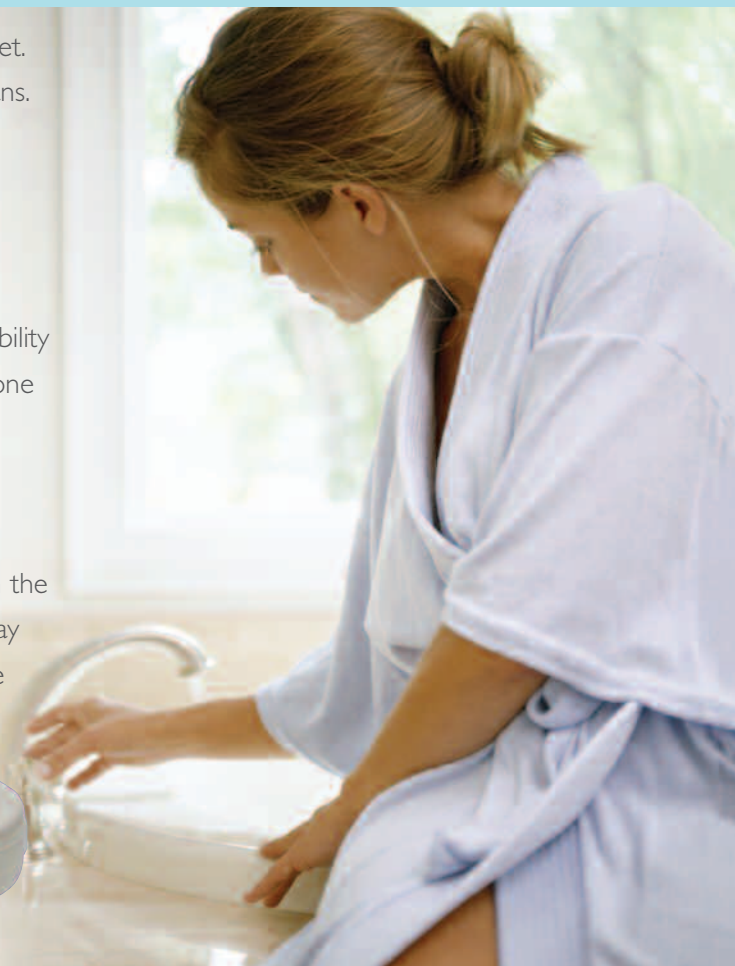

Ceiling Grille



Ceiling Grille with Dimmable Halogen Light



Energy Star Fluorescent Model

## Fantech's Popular Inline Fan At The Heart of Our Premium Bath Fans

At the heart of Fantech's Premium Bath Fans is a versatile inline fan powered by an external rotor motorized impeller.

This fine quality German manufactured motor is designed for long life and dependable performance.

Fan features a plastic housing constructed of UL-recognized and UV-protected thermoplastic resin. This tough protective shell allows the fan to be mounted in wet locations. UL tested and approved. HVI tested and certified for performance.

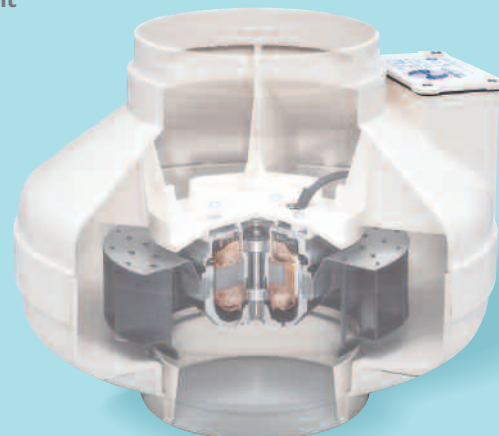

- **Prewired**
- **4" to 8" Duct; 100-360 cfm at .2 static**
- **100% speed controllable**
- **Powered by external rotor motorized impeller**
- **Five year factory warranty**
- **Rated for continuous duty**



Look for the Energy Star Label ... your assurance that Fantech Premium Bath Fans and Fans with Lights meet or exceed the energy efficiency requirements of Energy Star.

All models are UL Listed for use in wet locations. HVI (Home Ventilating Institute) certified for performance. All models are IC Rated.

# Bath Fans & Fans with Lights – Single Grilles



Clear the air in smaller baths and powder rooms with the help of a Fantech Premium Bath Fan or Bath Fan with Light.

A small-scale grille mounts in the ceiling while the fan motor mounts in a remote location away from the living area. The result is quiet yet powerful ventilation that is sure to protect your home from the damaging effects of moisture, steam and mold.

## FAN SIZING FOR BATHS UNDER 100 SQ. FT.

According to the guidelines of HVI (Home Ventilating Institute) baths 100 square feet or smaller require one CFM per square foot of bathroom\*. To find the square footage simply multiply the length of the bath by the width.

### EXAMPLE

7' x 9' bath = 63 sq. ft.

**YOU WILL NEED  
A 63 CFM FAN.**

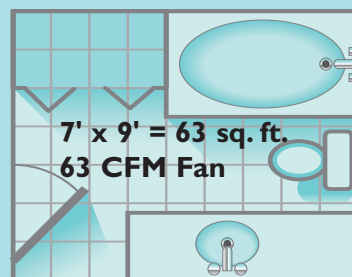

\* Minimum 50 CFM

NOTE: For proper airflow in typical installations (when duct losses aren't calculated), use the 0.4"Ps (static pressure) rating point for correct fan selection.



**PB100 Bath Fan**

100 CFM fan, one Ceiling Grille and grille housing with damper. Uses 4" duct. Energy Star Rated.

**PB190 Premium Bath Fan**

190 CFM fan, one Ceiling Grille, and grille housing with damper. Uses 6" duct. Grille housing fits between 2 x 8 construction. Energy Star Qualified.



**Ceiling Grille with Dimmable Halogen Light (7" Diameter)**



**PB100F Bath Fan with Fluorescent Light**

100 CFM bath fan, one Ceiling Grille with Light, grille housing with damper, and 14-watt, instant-on, fluorescent bulb. Uses 4" duct. Energy Star Rated. UL Listed for wet locations.



**PB100H Bath Fan with Dimmable Halogen Light**

100 CFM bath fan, one Ceiling Grille with Light, grille housing with damper, and 50-watt halogen bulb. Uses 4" duct. UL Listed for wet locations.

**Contractor Friendly Installation**

Fantech Premium Bath Fans are "flex duct friendly" making installation fast and easy. We recommend:

1. Use insulated flexible duct. (Insulated flex duct allows sound from the fan to dissipate gradually so that it can not be heard in the bathroom.)
2. Ideally you should have at least 8 feet of flex duct between ceiling grilles and fan.
3. If applicable, use multiple ceiling grilles or ceiling grilles with lights.



**Did You Know??**



The Home Ventilating Institute (HVI) recommends that "the bath fan be left on 20 minutes after the use of the bathroom" to successfully fight the damaging effects of moisture.

A timer such as Fantech's Electronic Pushbutton Timer (Model FD60EM) is the ideal answer.

Simply push 10, 20, 30 or 60 minutes then exit the bathroom. Timer will keep the fan running for the amount of time you specify then turn off automatically.

# Bath Fans & Fans with Lights – Dual Grilles



As the trend to larger spa-like bathrooms continues to gain in popularity, the need for proper ventilation becomes more important.

Gone are the days of a single bath fan in the center of the room. The key to proper ventilation in oversized baths filled with luxurious amenities is true spot ventilation at the source.

Quick removal of moisture at the source will keep your beautiful bath free of mold and the effects of extreme moisture.

Fantech has developed its Premium Bath Fans so that one remote mounted fan motor can effectively ventilate several areas of the bath.

Ceiling Grilles or Ceiling Grilles with Lights can be easily positioned over showers, whirlpool tubs, steam showers, toilet and vanity.

## FAN SIZING FOR BATHS OVER 100 SQ. FT.

Ventilation for baths over 100 square feet is calculated based on the fixtures in the bath. Allow 50 CFM for each standard toilet, shower or tub. Whirlpool and jetted tubs are calculated at 100 CFM. Add up the CFMs for all fixtures and you'll have the total CFMs required.

### EXAMPLE

11' x 14' Bath =	154 square feet
1 Toilet + 1 Shower + 1 Tub =	150 CFM
1 Toilet	50 CFM
1 Shower	50 CFM
1 Tub	50 CFM
<hr/> Total	<hr/> 150 CFM

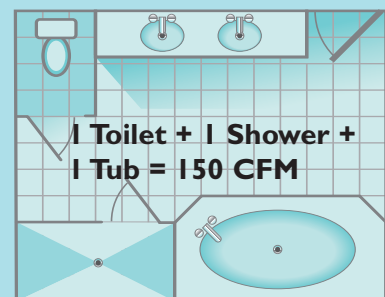

### YOU WILL NEED A 150 CFM FAN.

**NOTE:** Fantech recommends that steam showers use a separate fan on a timer so that the fan may be shut off during shower use and then run afterward to dry the shower stall.

For proper airflow in typical installations (when duct losses aren't calculated), use the 0.4"Ps (static pressure) rating point for correct fan selection.



**PB230-2 Premium Bath Fan with Dual Grilles**

230 CFM fan, two Ceiling Grilles, two grille housings with dampers and Y-adapter (4x4x6). Uses 4" and 6" duct. Energy Star Qualified.



**Premium Bath Fans – Dual Grille Models – Two Locations (Vent Only)**



**PB360-2 Larger Premium Bath Fan with Dual Grilles**

360 CFM fan, two Ceiling Grilles, two grille housings with dampers and Y adapter (6x6x8). Uses 6" and 8" duct. Grille housing fits between 2 x 8 construction. Energy Star Qualified.

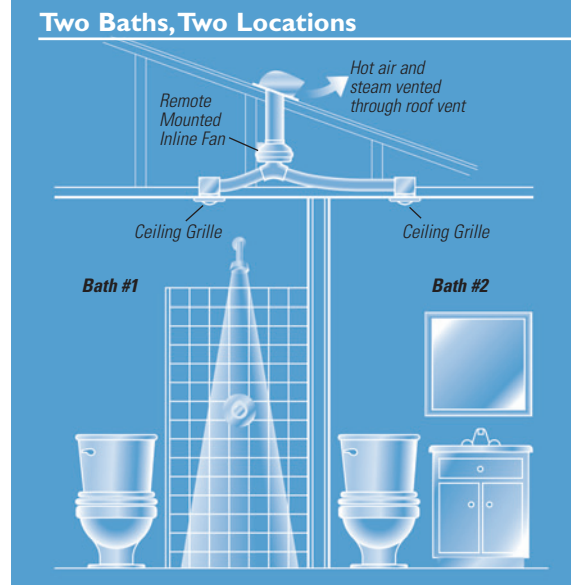

**Premium Bath Fans with Lights – Dual Grille Models – Two Locations**



**PB230F-2 Premium Bath Fan – Dual Grilles with Fluorescent Lights**

230 CFM fan, two Ceiling Grilles with Lights, two grille housings with dampers, two 14 watt instant-on Fluorescent bulbs and Y adapter (4x4x6). Uses 4" and 6" duct. Energy Star Qualified. UL Listed for wet locations.



**PB230H-2 Premium Bath Fan – Dual Grilles with Dimmable Halogen Lights**

230 CFM fan, two Ceiling Grilles with Lights, two grille housings with dampers, two 50 watt Halogen bulbs and Y-adapter (4x4x6). Uses 4" and 6" duct. UL Listed for wet locations.

# Combination Bath Fans – Dual Grilles



Fantech takes the work out of choosing the right bath fan for your new home or remodeling project.

## **Premium Bath Combination Units.**

Combo units include one exhaust fan, one lit and one unlit Ceiling Grille. A single model number provides the exact bath fan components to install an effective two-location exhaust system.

**Want to add an additional exhaust location?** Just choose an additional Ceiling Grille with or without a light to turn your one or two location bath fan into a fabulous multiport system.

## Combination Units - Dual Grilles - One Lit/One Unlit



### **PB230FV-2 Fan with One Ceiling Grille with Fluorescent Light and One Vent-Only Ceiling Grille**

230 CFM fan, one Ceiling Grille with Light, one Vent-Only Ceiling Grille, two grille housings with dampers, one 14 watt instant-on Fluorescent bulb and Y adapter (4x4x6). Uses 4" and 6" duct. Energy Star Qualified. UL Listed for wet locations.



### **PB230HV-2 Fan with One Dimmable Halogen Light and One Ceiling Grille**

230 CFM fan, one Ceiling Grille with Light, One Vent-Only Ceiling Grille, two grille housings with dampers, one 50 watt Halogen bulb and Y adapter (4x4x6). Uses 4" and 6" duct. Energy Star Qualified. UL Listed for wet locations.



# Exterior Mount Bath Fans & Expansion Grilles

Fantech has expanded its Premium Bath Fan selection to include a trio of models powered by exterior mounted wall fans. An excellent alternative when space is an issue or direct venting to the outside is required. Ideal for homes, condominiums and apartment complexes. Choose vent only or lighted models.



**PBWI10H Exterior Wall Mount Bath Fan with Dimmable Halogen Light**  
110 CFM fan, one Ceiling Grille with Light, grille housing with damper and 50 watt halogen bulb. UL Listed for wet locations.



## Exterior Mount Bath Fans



**PBWI10 Exterior Wall Mount Bath Fan**  
110 CFM fan, one Ceiling Grille and grille housing with damper.



**PBWI10F Exterior Wall Mount Bath Fan with Fluorescent Light**  
110 CFM fan, one Ceiling Grille, one grille housing with damper and one 14-watt instant-on fluorescent bulb. UL Listed for wet locations.

### Ideal for First Floor Baths

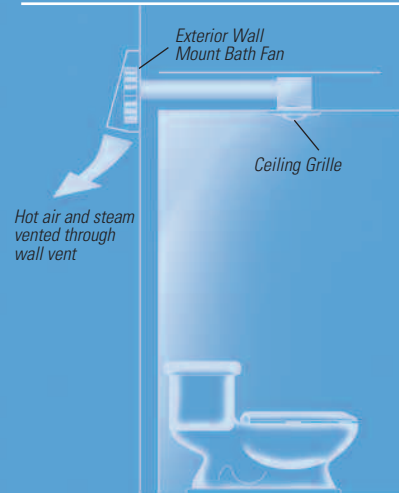

## Expansion Grilles with Housings – Vent Only or Lighted Models



**PBF4 Ceiling Grille with Fluorescent Light**  
For use with Fantech remote fans. Includes Ceiling Grille with Fluorescent light, grille housing with damper, four hanger bars and 14-watt instant-on fluorescent bulb. Grille housing: 6"L x 6"W x 5 1/4"H. Fits between 2x6 construction.



**PBH4 Ceiling Grille with Dimmable Halogen Light**  
For use with Fantech remote fans. Includes Ceiling Grille with Halogen light, grille housing with damper, four hanger bars and 50-watt halogen bulb. Grille housing: 6"L x 6"W x 5 1/4"H. Fits between 2x6 construction.













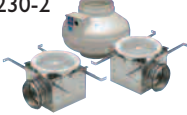

**PBV4 Ceiling Grille**  
For use with Fantech remote fans. Includes Ceiling Grille, grille housing with damper and four hanger bars. Grille housing: 6"L x 6"W x 5 1/4"H. Fits between 2x6 construction.



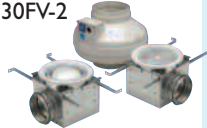

**PBV6 Ceiling Grille**  
For use with Fantech remote fans. Includes Ceiling Grille, grille housing with damper and four hanger bars. Grille housing: 8"L x 8"W x 7 1/8"H. Fits between 2x8 construction.



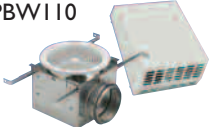
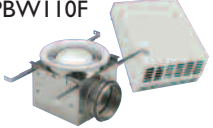

# Quick View Selection Guide

Fantech Premium Bath Fan Model Number	CFM at .2 Static Pressure	CFM at .4 Static Pressure	CFM at .6 Static Pressure	Watts at .2 Static Pressure	Duct Size			Lamp
<b>PREMIUM BATH FANS</b>								
PB100 	100	78	55	19	4"	Yes	Yes	–
PB190 	190	162	132	61	6"	Yes	Yes	–
<b>PREMIUM BATH FANS - DUAL GRILLES</b>								
PB230-2 	230	198	167	71	4"/6"	Yes	Yes	–
PB360-2 	360	308	259	122	6"/8"	Yes	Yes	–
<b>PREMIUM BATH FANS WITH LIGHTS</b>								
PB100F 	100	78	55	19	4"	Yes	Yes	14 Watt Instant-on Compact Fluorescent (TCPXR3014)*
PB100H 	100	78	55	19	4"	–	Yes	50 Watt Halogen PAR16/MR16GU10
<b>PREMIUM BATH FANS WITH LIGHTS - DUAL GRILLES</b>								
PB230F-2 	230	198	167	71	4"/6"	Yes	Yes	14 Watt Instant-on Compact Fluorescent (TCPXR3014)*
PB230H-2 	230	198	167	71	4"/6"	–	Yes	50 Watt Halogen PAR16/MR16GU10
<b>PREMIUM BATH FANS - COMBINATION UNITS - ONE LIT AND ONE UNLIT GRILLE</b>								
PB230FV-2 	230	198	167	71	4"/6"	Yes	Yes	14 Watt Instant-on Compact Fluorescent (TCPXR3014)*
PB230HV-2 	230	198	167	71	4"/6"	–	Yes	50 Watt Halogen PAR16/MR16GU10

\* The Compact Fluorescent bulb used in Fantech Premium Bath Fans has a color temperature of 2733 Kelvin and CRI of 81. Average bulb life: 10,000 hours. For replacement bulbs, contact Fantech at [www.fantech.net](http://www.fantech.net).

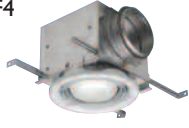
Fantech Premium Bath Fan Model Number	CFM at .1 Static Pressure	CFM at .2 Static Pressure	CFM at .4 Static Pressure	Watts at .2 Static Pressure	Duct Size		Lamp
<b>EXTERIOR WALL MOUNT FANS AND FANS WITH LIGHTS</b>							
PBW110 	110	97	71	19	4"	Yes	—
PBW110F 	110	97	71	19	4"	Yes	14 Watt Instant-on Compact Fluorescent (TCPXR3014)*
PBW110H 	110	97	71	19	4"	Yes	50 Watt Halogen PAR16/MRI6GU10

\* The Compact Fluorescent bulb used in Fantech Premium Bath Fans has a color temperature of 2733 Kelvin and CRI of 81. Average bulb life: 10,000 hours. For replacement bulbs, contact Fantech at [www.fantech.net](http://www.fantech.net).

Fantech Premium Bath Fan Model Number	Duct Size	Housing Dimensions		Lamp
<b>EXPANSION GRILLES WITH HOUSINGS AND DAMPERS</b>				
PBF4 	4"	6"L x 6"W x 5 1/4"H	Yes	14 Watt Instant-on Compact Fluorescent (TCPXR3014)*
PBH4 	4"	6"L x 6"W x 5 1/4"H	—	50 Watt Halogen PAR16/MRI6GU10
PBV4 	4"	6"L x 6"W x 5 1/4"H	NA	—
PBV6 	6"	8"L x 8"W x 7 1/8"H	NA	—

\* The Compact Fluorescent bulb used in Fantech Premium Bath Fans has a color temperature of 2733 Kelvin and CRI of 81. Average bulb life: 10,000 hours. For replacement bulbs, contact Fantech at [www.fantech.net](http://www.fantech.net).

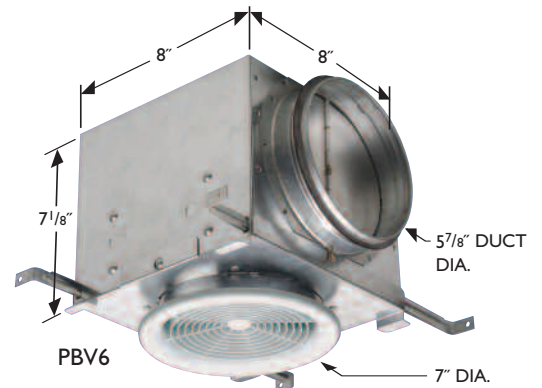
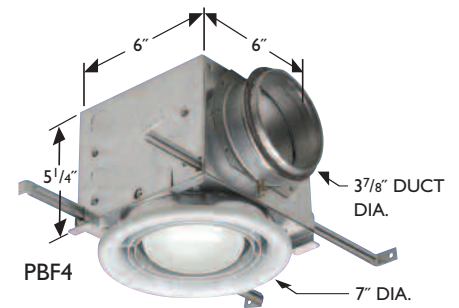

Fantech Recommends the Use of Insulated Flex Duct with Fantech Premium Bath Fans



# Controls & Accessories



**FD60EM**  
**Electronic Timer Control**  
10, 20, 30, 60 minute timer.  
Decora style switch plate.  
115V/20A



**FLD60**  
**Fan Delay Timer**  
Set timer so fan continues to operate after light has been turned off.

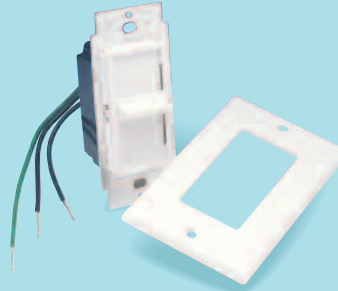

**SCD5**  
**Slide Speed Control**  
Decora style slide control with on/off. 115 V/5A



**FIDT**  
**Insulated Flex Duct**  
Box of 25 feet. Available in 4", 6" or 8" duct.

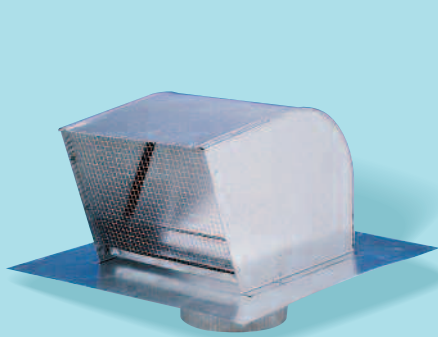

**RC**  
**Roof Caps**  
For 4, 6 or 8" round duct.  
4" duct (Aluminum)  
6" or 8" duct (Galvanized Steel).  
Includes bird screen.

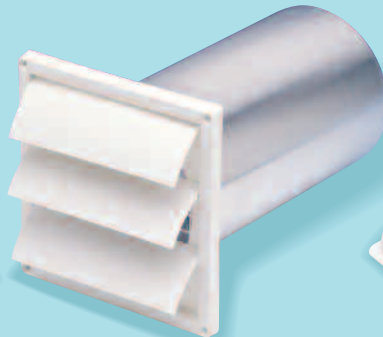

**HS4W/HS6W**  
**Louvered Shutters**  
Plastic with tailpiece.  
Two models for 4" or 6" duct.



**UEV4**  
**Soffit Vent**  
For 4 -5" round duct. Plastic.



**FY Series**  
**"Y" Duct Adapters**  
Five different models to choose from. 4x4x4"; 6x6x6"; 6x6x4"; 6x4x4"; 8x6x6".

For additional information on items shown above, see The Fantech Accessories Book on the web at [www.fantech.net](http://www.fantech.net).



**United States**  
1712 Northgate Blvd., Sarasota, FL 34234  
Phone: 800-747-1762; 941-309-6000  
Fax: 800-487-9915; 941-309-6099  
[www.fantech.net](http://www.fantech.net); [info@fantech.net](mailto:info@fantech.net)

**Canada**  
50 Kanalfakt Way, Bouctouche, NB E4S 3M5  
Phone: 800-565-3548; 506-743-9500  
Fax: 877-747-8116; 506-743-9600  
[www.fantech.ca](http://www.fantech.ca); [info@fantech.ca](mailto:info@fantech.ca)

Fantech, reserves the right to modify, at any time and without notice, any or all of its products' features, designs, components and specifications to maintain their technological leadership position.

Item#412220 SBB0406

©2006 Fantech, Inc. All Rights Reserved.

Distributed locally by:

